

EFHC and EFHCA Fixture Hangers and Accessories

Explosionproof, Dust-Ignitionproof

UNILETS® for use with Threaded Metal Conduit.

NEC/CEC:

Class I, Division 1 and 2, Groups A^①, B, C, D

Class II, Division 1 and 2, Groups E, F, G

Class III

POLES/HANGERS: NEC/CEC EXPLOSIONPROOF FLEXIBLE FIXTURE HANGERS

Applications

- Fixture hangers and accessories for suspension of industrial type HID, incandescent, and fluorescent lighting fixtures in Class I, Class II, and Class III classified locations.
- Suitable for use in areas where moisture, dust and corrosive atmospheres are present.
- EFHC and EFHCA hangers have smooth, rounded integral bushing in each hub to protect conductor insulation.

Features

- EFHC and EFHCA Fixture Hangers are used where fixture stem is less than 304.8 mm (12 in) long or with EXJF, ESD, or ESS where fixture stem is more than 304.8 mm (12 in) long.
- Raintight when used with O-Ring.
- Provided with threaded removable cover for convenience in pulling or splicing conductors.
- Mounting strap available for fastening EFHC or EFHCA to a mounting surface.
- CB202 connection block available for convenience in connecting line and fixture wires without splices.
- Hanger has setscrew in stem hub to prevent fixture stem from turning.

Standard Materials

- EFHC and EFHCA fixture hanger body: malleable iron
- EFHC and EFHCA fixture cover: copperfree (4/10 of 1% max.) aluminum
- EFHC and EFHCA mounting strap and LC locking coupling: steel

Standard Finishes

- EFHC and EFHCA fixture hanger body: triple-coat – 1) zinc electroplate, (2) chromate, and (3) epoxy powder coat
- EFHC and EFHCA fixture hanger cover: epoxy powder coat
- EFHC/EFHCA mounting strap and LC locking coupling: zinc electroplate

NEC/CEC Certifications and Compliances

- UL Listed: E10444
- UL Standard: 1203
- CSA Certified: 025875



EFHC



EFHCA

Illustrated Features

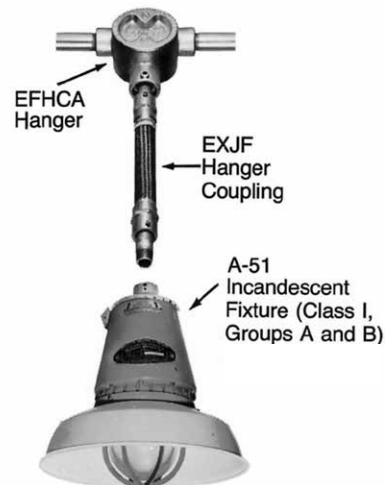

^① Suitable for Class I, Groups A, B, C, D.

EFHC and EFHCA Fixture Hangers and Accessories

Explosionproof, Dust-Ignitionproof

UNILETS® for use with Threaded Metal Conduit.

NEC/CEC:

Class I, Division 1 and 2, Groups A⓪, Bⓧ, C, D
 Class II, Division 1 and 2, Groups E, F, G
 Class III

	Conduit Size (Inches)	Fixture Stem Size (Inches)	Catalog Number
EFHC Fixture Hanger			
	Class I, Groups B*, C and D Class II, Groups E, F and G Class III		
	3/4	1/2	EFHC7550 ♦
	3/4	3/4	EFHC7575 ♦
	1	1/2	EFHC1050 ♦
	1	3/4	EFHC1075 ♦

EFHCA Fixture Hanger			
	Class I, Groups A⓪, B, C and D Class II, Groups E, F and G Class III		
	3/4	1/2	EFHCA7550 ①
	3/4	3/4	EFHCA7575 ①
	1	1/2	EFHCA1050 ①
	1	3/4	EFHCA1075 ①

EFHC and EFHCA Connection Block Accessory – Porcelain			
	Designed to fit in hanger without fastening. 2 Wire, 20 Amp 277 Volt Maximum Wire Size Two No. 10 AWG large terminal Two No. 14 AWG small terminal		CB202

EFHC and EFHCA Steel Mounting Strap			
	For fastening EFHC or EFHCA to a mounting surface.		
	Add suffix S to above EFHCA or EFHC catalog numbers.		Add suffix S

Dimensions in Millimeters (Inches)

EFHCA and EFHC Fixture Hangers

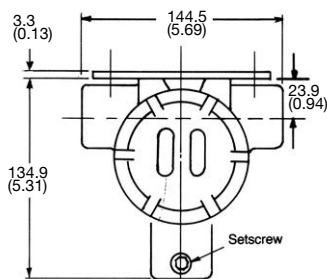

Optional Mounting Strap

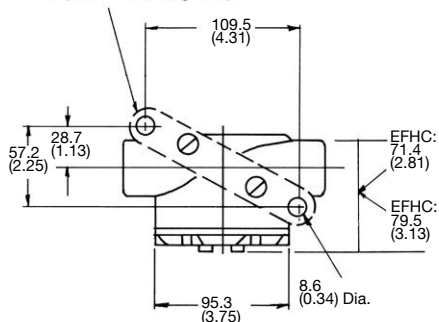

FHS Rigid Support

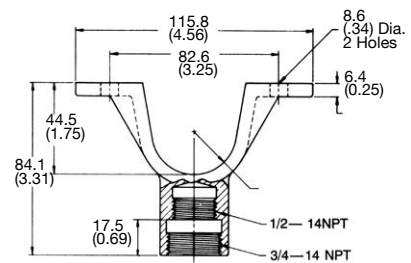

① Suitable for Class I, Groups A, B, C and D.

♦ Shaded area indicates items suitable for Class I, Groups B, C and D; Class II, Groups E, F and G; and Class III. Sealing fitting must be installed adjacent to enclosure for all conduits for Group B location (EFHC Series).

POLES/HANGERS: NEC/CEC EXPLOSIONPROOF FLEXIBLE FIXTURE HANGERS

Appleton